

PARLOR CLEAN-UP



*Agpro is the Source for
all your Waste Handling
needs.*

✓ **YOU SHOULD REALLY FLUSH YOUR PARLOR !**



The common way - Just Hose Manure Out



The common way - Just Hose Manure Out



- Parlor & Holding Pen Flush – 2 Choices

- ✓ Flush Tank



- ✓ Flush Valve & Reservoir

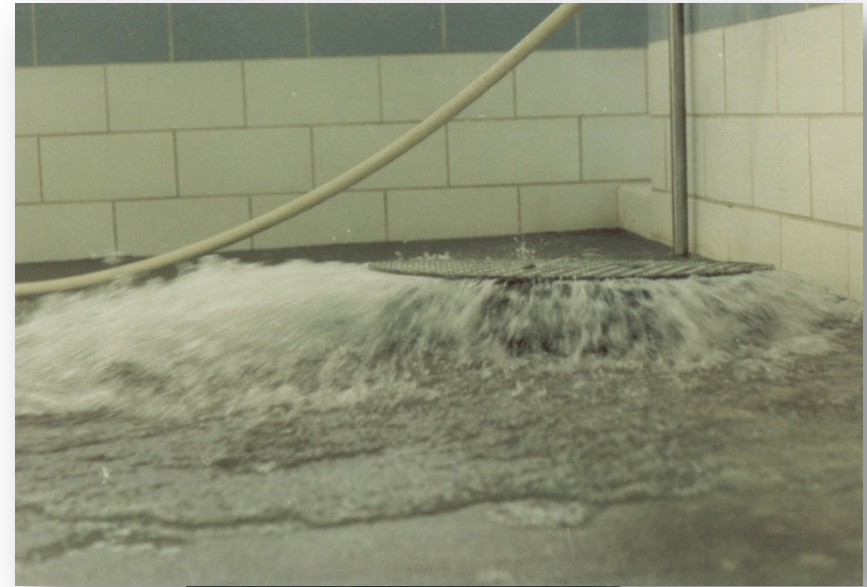

- Flush Tanks
- ✓ Complete Self Contained Units



- Flush Tanks
- ✓ Complete Self Contained Units



- 2m³ to 5m³ capacity
- 150Lps



- Flush Tanks – Typical System Layout

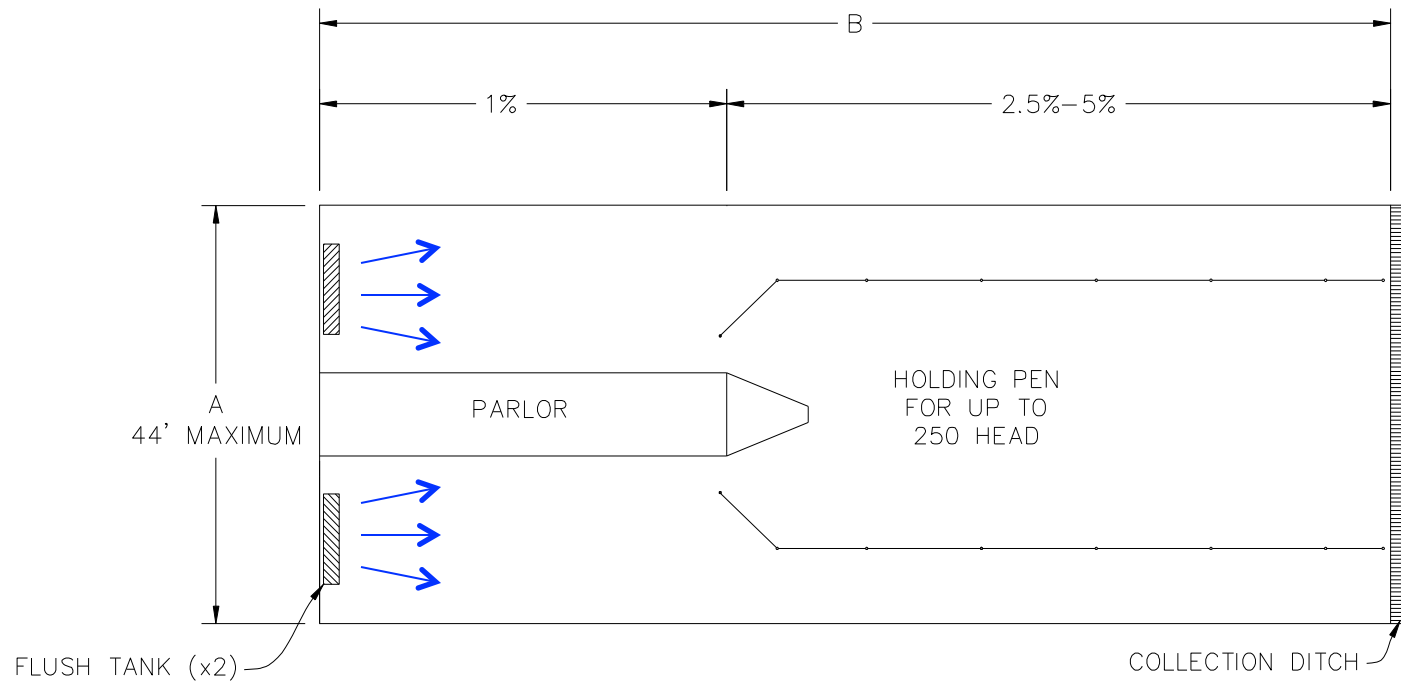

- Flush Tanks



- Additional applications of Flush Tanks
 - ✓ Applicable to many places, especially where only one or two lanes required
 - ✓ Ideal for fresh water flush
 - ✓ Great for small remote areas



- Flush Valves and Reservoir

220 Lps

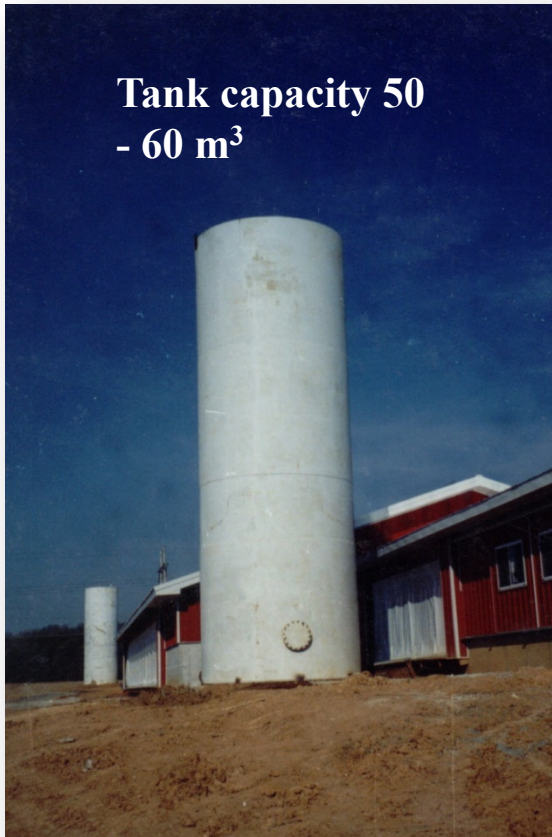

315mm diameter pipe



■ Flush Valves & Reservoir – Typical System Layout

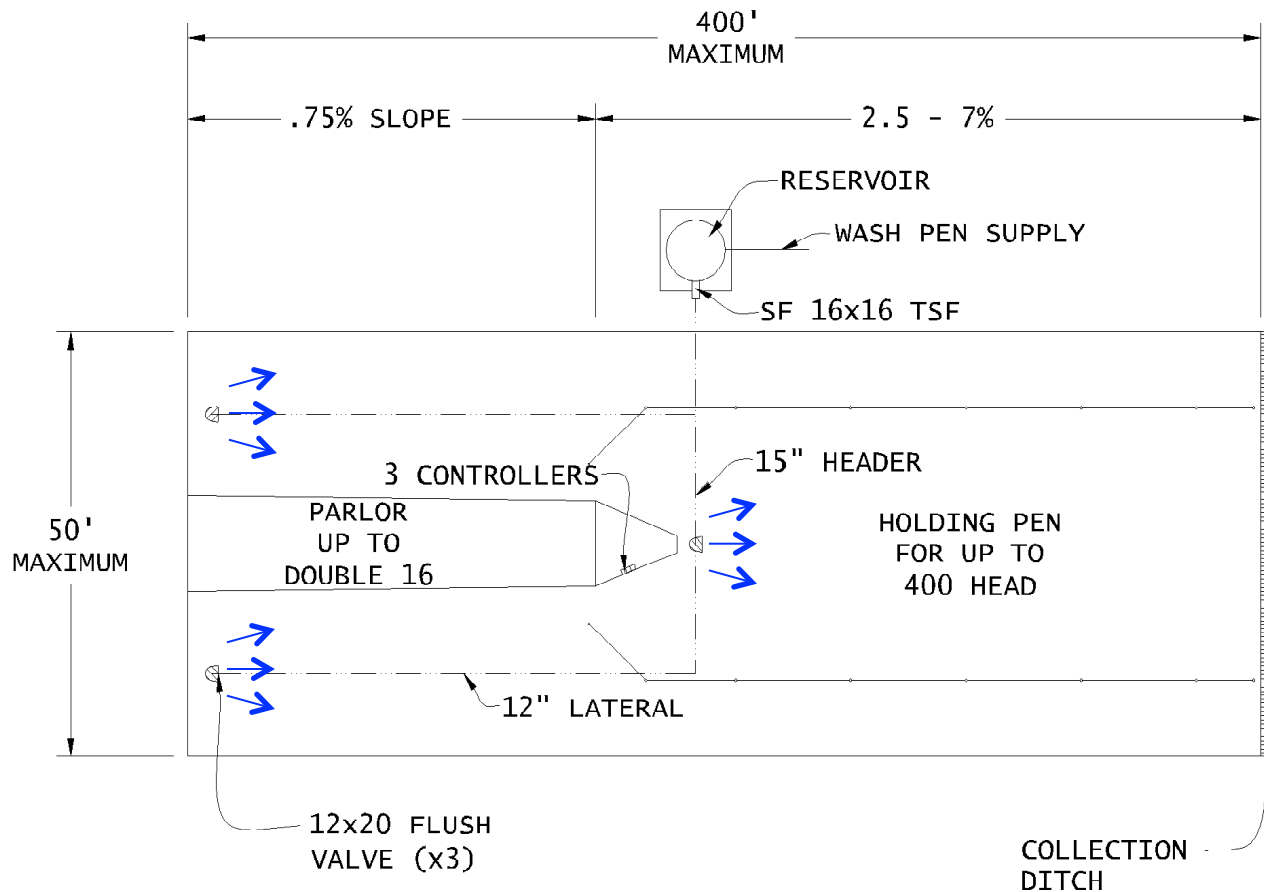

- Valve Flushing



- Double Slope Parlors



**Two
Valves
Back to Back**

Removable Handle

Rotatable Valve

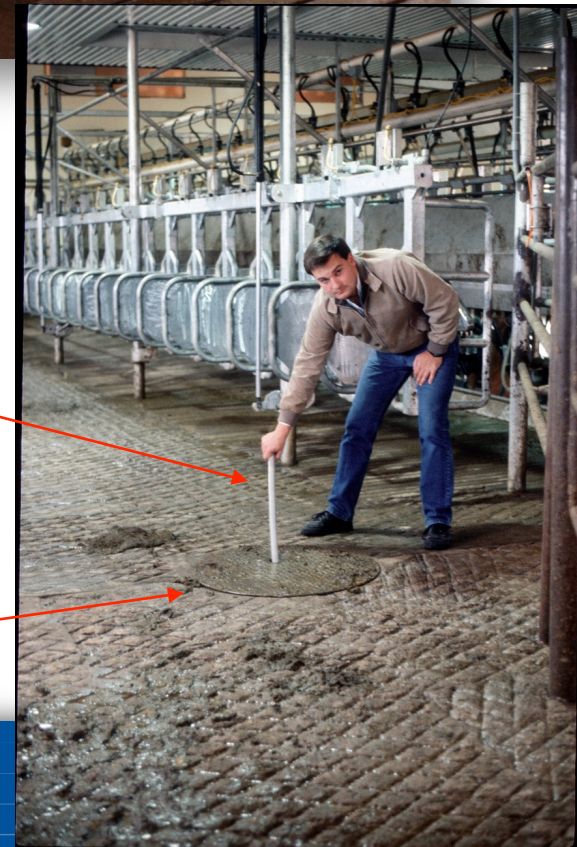

■ Advantages of High Flow Rates

- ✓ The quicker we get the required volume on the floor the smaller the volume
- ✓ The turbulent wave action breaks-up manure and aides rapid removal
- ✓ Steeper slopes help the efficiency



- Deck Wash Systems



Nozzle at Every Other Stall



Wash Head

Minimal misting

Note complete wash coverage, no dead area





✓ Deck Jet Parlor Wash



✓ Deck Jet Parlor Wash

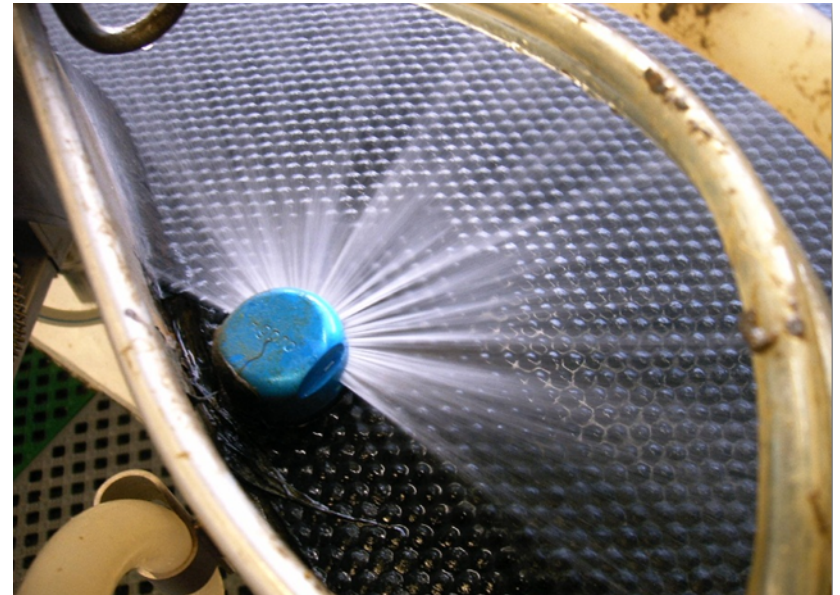
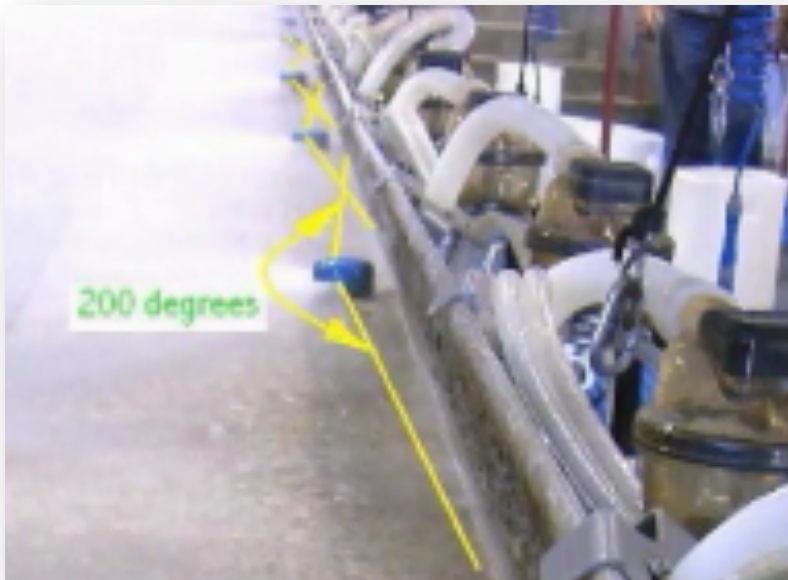

Review :

- Parlor/Holding Pen hose down alternative
- Capable of cleaning only at the end of each milking
- Labor intensive
- Increased total water usage
- Doesn't get done



✓ Parlor Flush Results





✓ ***YOU SHOULD REALLY FLUSH
YOUR PARLOR !***

- ✓ Labor efficient. Complete cleanup in seconds
- ✓ Same or less amount of water required if managed properly
- ✓ Ability to cleanup at any time, even when cows are present



QUESTIONS ?



GRACIAS !

